

# Ymer-D1 free standing luminaire



20.002.36009



## GENERAL

Floor  
Standing  
Silver  
IP20  
indirect 14800 lm  
direct 4200 lm  
total 19000 lm  
Beam Angle  $\uparrow 115^\circ / 75^\circ \downarrow$   
UGR < 16

## LED

3000~6000K Variable  
CRI  $\geq 80$   
L80(B10)50,000H  
SDCM < 3

## PHYSICAL

length 760 mm  
width 594 mm  
height 2000 mm  
22 kg

## ELECTRICAL

150W  
135 lm/W  
200~240V AC

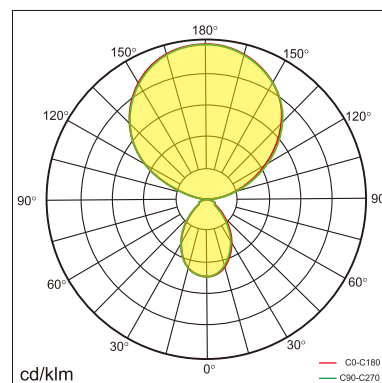
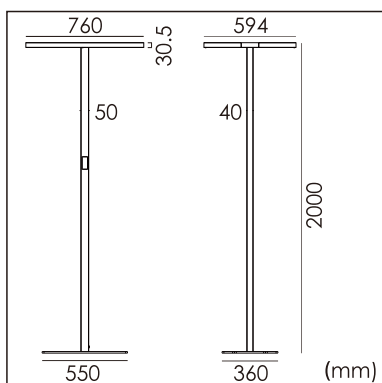

The data values for the luminous flux are initially subject to a tolerance of +/- 10%, those for the electrical connected load are initially subject to a tolerance of +/- 10%, and those for the colour temperature are initially subject to a tolerance of +/- 150 K. Product illustrations serve as examples and may differ from the original. No liability is assumed for typographical or printing errors. We reserve the right to make alterations in the interest of improving our products.