

Frigg-F

free standing luminaire



20.008.14002



GENERAL

Floor
Standing
black
IP20
indirect 6050 lm
direct 2250 lm
total 8300 lm
Beam Angle $\uparrow 140^\circ/85^\circ\downarrow$
UGR<10

LED

4000K neutral white
CRI ≥ 80
L80(B10)50,000H
SDCM <3

PHYSICAL

length 1070 mm
width 336 mm
height 1980 mm
16 kg

ELECTRICAL

80W
110 lm/W
AC200~240V

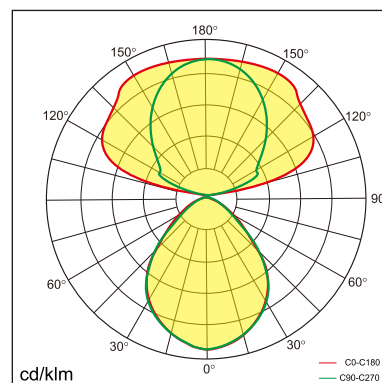
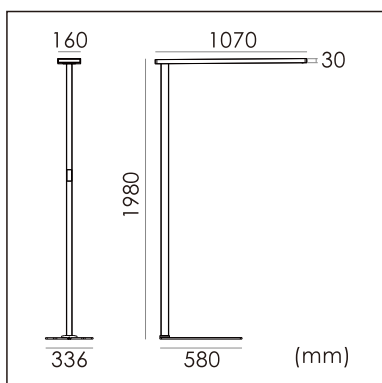

The data values for the luminous flux are initially subject to a tolerance of +/- 10%, those for the electrical connected load are initially subject to a tolerance of +/- 10%, and those for the colour temperature are initially subject to a tolerance of +/- 150 K. Product illustrations serve as examples and may differ from the original. No liability is assumed for typographical or printing errors. We reserve the right to make alterations in the interest of improving our products.