

Ymer-D2 free standing luminaire



20.003.13001



GENERAL

Floor
Standing
black
IP20
indirect 15250 lm
direct 4550 lm
total 19800 lm
Beam Angle $\uparrow 115^\circ / 75^\circ \downarrow$
UGR < 16

LED

3000K warm white
CRI ≥ 80
L80(B10)50,000H
SDCM < 3

PHYSICAL

length 1634 mm
width 360 mm
height 2000 mm
22.5 kg

ELECTRICAL

150W
135 lm/W
200~240V AC

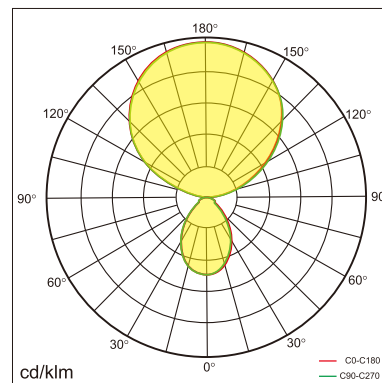
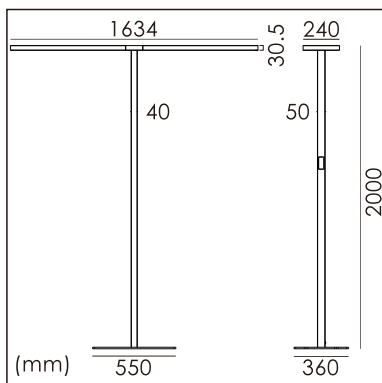

The data values for the luminous flux are initially subject to a tolerance of +/- 10%, those for the electrical connected load are initially subject to a tolerance of +/- 10%, and those for the colour temperature are initially subject to a tolerance of +/- 150 K. Product illustrations serve as examples and may differ from the original. No liability is assumed for typographical or printing errors. We reserve the right to make alterations in the interest of improving our products.