

20.007.23013



GENERAL

Floor
 Standing
 White
 IP20
 indirect 9500 lm
 direct 2500 lm
 total 12000 lm
 Beam Angle $\uparrow 140^\circ/85^\circ\downarrow$
 UGR<14

LED

3000K warm white
 CRI ≥ 80
 L80(B10)50,000H
 SDCM <3

PHYSICAL

length 1006 mm
 width 336 mm
 height 1980 mm
 16 kg

ELECTRICAL

100W
 120 lm/W
 AC200~240V

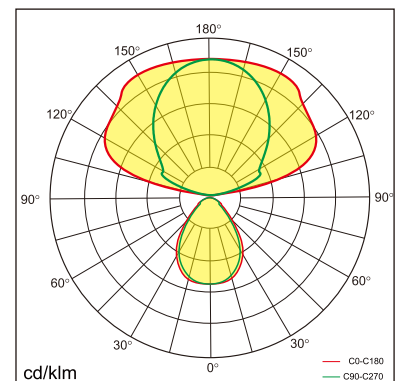
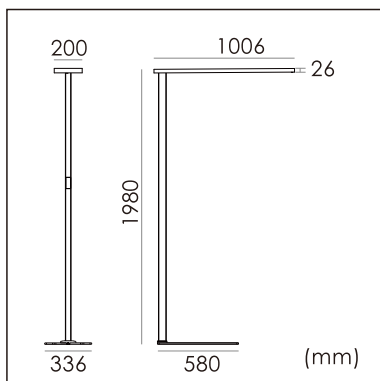

The data values for the luminous flux are initially subject to a tolerance of +/- 10%, those for the electrical connected load are initially subject to a tolerance of +/- 10%, and those for the colour temperature are initially subject to a tolerance of +/- 150 K. Product illustrations serve as examples and may differ from the original. No liability is assumed for typographical or printing errors. We reserve the right to make alterations in the interest of improving our products.