

# Heimdall free standing luminaire

20.006.34008



## GENERAL

Floor  
Standing  
Silver  
IP20  
indirect 12000 lm  
direct 1700 lm  
total 13700 lm  
Beam Angle  $\uparrow 140^\circ/80^\circ\downarrow$   
UGR < 10

## LED

4000K neutral white  
CRI  $\geq 80$   
L80(B10) 50,000H  
SDCM < 3

## PHYSICAL

length 1180 mm  
width 336 mm  
height 1975 mm  
17 kg

## ELECTRICAL

110W  
120 lm/W  
200~240V AC

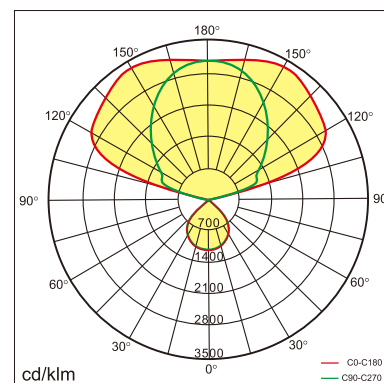
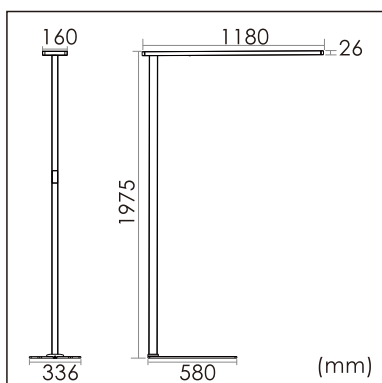

The data values for the luminous flux are initially subject to a tolerance of +/- 10%, those for the electrical connected load are initially subject to a tolerance of +/- 10%, and those for the colour temperature are initially subject to a tolerance of +/- 150 K. Product illustrations serve as examples and may differ from the original. No liability is assumed for typographical or printing errors. We reserve the right to make alterations in the interest of improving our products.