

# Siv-D free standing luminaire

20.010.33016



## GENERAL

Floor  
Standing  
Silver  
IP20  
indirect 13500 lm  
direct 4500 lm  
total 18000 lm  
Beam Angle  $\uparrow 140^\circ/50^\circ\downarrow$   
UGR<12

## LED

3000K warm white  
CRI  $\geq 80$   
L80(B10)50,000H  
SDCM <3

## PHYSICAL

length 2372 mm  
width 477 mm  
height 1960 mm  
19 kg

## ELECTRICAL

150W  
120 lm/W  
200~240V AC

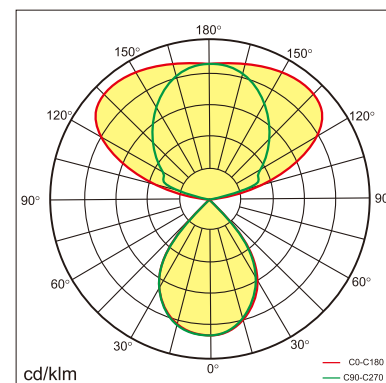
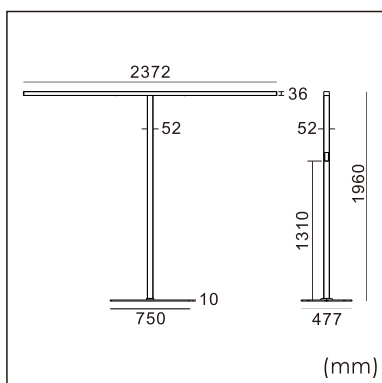

The data values for the luminous flux are initially subject to a tolerance of +/- 10%, those for the electrical connected load are initially subject to a tolerance of +/- 10%, and those for the colour temperature are initially subject to a tolerance of +/- 150 K. Product illustrations serve as examples and may differ from the original. No liability is assumed for typographical or printing errors. We reserve the right to make alterations in the interest of improving our products.