

20.019.23003



GENERAL

Floor
 Standing
 White
 IP20
 indirect 3500 lm
 direct 3100 lm
 total 6600 lm
 Beam Angle $\uparrow 110^\circ / 90^\circ \downarrow$
 UGR < 17

LED

3000K warm white
 CRI ≥ 80
 L80(B10)50,000H
 SDCM < 3

PHYSICAL

length 610 mm
 width 280 mm
 height 1950 mm
 12.5 kg

ELECTRICAL

60W
 110 lm/W
 AC200~240V

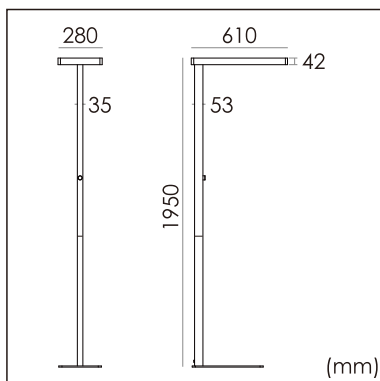

The data values for the luminous flux are initially subject to a tolerance of +/- 10%, those for the electrical connected load are initially subject to a tolerance of +/- 10%, and those for the colour temperature are initially subject to a tolerance of +/- 150 K. Product illustrations serve as examples and may differ from the original. No liability is assumed for typographical or printing errors. We reserve the right to make alterations in the interest of improving our products.