

20.017.34018



### GENERAL

Floor  
 Standing  
 Silver  
 IP20  
 indirect 3500 lm  
 direct 3100 lm  
 total 6600 lm  
 Beam Angle  $\uparrow 110^\circ/90^\circ \downarrow$   
 UGR<17

### LED

4000K neutral white  
 CRI  $\geq 80$   
 L80(B10)50,000H  
 SDCM <3

### PHYSICAL

length 610 mm  
 width 280 mm  
 height 1950 mm  
 12.5 kg

### ELECTRICAL

60W  
 110 lm/W  
 AC200~240V

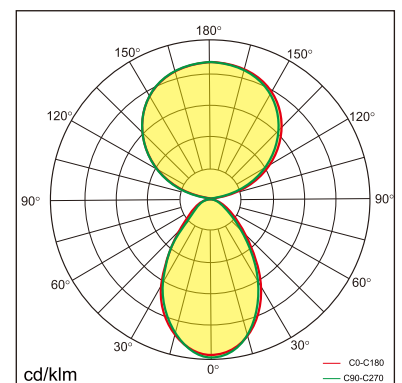
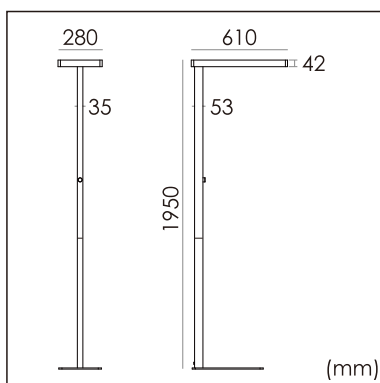

The data values for the luminous flux are initially subject to a tolerance of +/- 10%, those for the electrical connected load are initially subject to a tolerance of +/- 10%, and those for the colour temperature are initially subject to a tolerance of +/- 150 K. Product illustrations serve as examples and may differ from the original. No liability is assumed for typographical or printing errors. We reserve the right to make alterations in the interest of improving our products.