

Thor-O free standing luminaires



20.016.14032



GENERAL

Floor
Standing
black
IP20
indirect 4600 lm
direct 4200 lm
total 8800 lm
Beam Angle $\uparrow 110^\circ/90^\circ \downarrow$
UGR < 17

LED

4000K neutral white
CRI ≥ 80
L80(B10)50,000H
SDCM < 3

PHYSICAL

length 610 mm
width 300 mm
height 1950 mm
12.5 kg

ELECTRICAL

80W
110 lm/W
200~240V AC

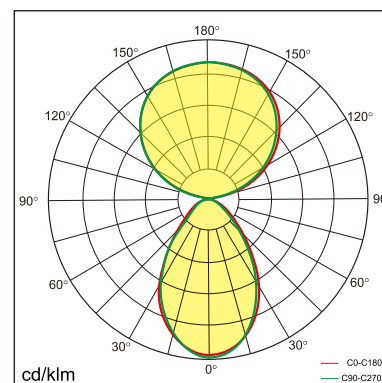
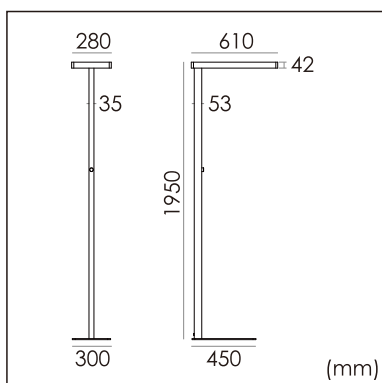

The data values for the luminous flux are initially subject to a tolerance of +/- 10%, those for the electrical connected load are initially subject to a tolerance of +/- 10%, and those for the colour temperature are initially subject to a tolerance of +/- 150 K. Product illustrations serve as examples and may differ from the original. No liability is assumed for typographical or printing errors. We reserve the right to make alterations in the interest of improving our products.