

# Thor-O

free standing luminaires



20.016.13019



## GENERAL

Floor  
Standing  
black  
IP20  
indirect 4600 lm  
direct 4200 lm  
total 8800 lm  
Beam Angle  $\uparrow 110^\circ/90^\circ \downarrow$   
UGR < 17

## LED

3000K warm white  
CRI  $\geq 80$   
L80(B10)50,000H  
SDCM < 3

## PHYSICAL

length 610 mm  
width 300 mm  
height 1950 mm  
12.5 kg

## ELECTRICAL

80W  
110 lm/W  
200~240V AC

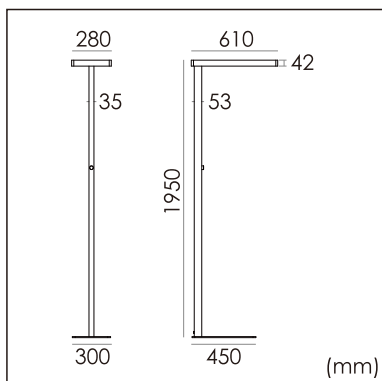

The data values for the luminous flux are initially subject to a tolerance of +/- 10%, those for the electrical connected load are initially subject to a tolerance of +/- 10%, and those for the colour temperature are initially subject to a tolerance of +/- 150 K. Product illustrations serve as examples and may differ from the original. No liability is assumed for typographical or printing errors. We reserve the right to make alterations in the interest of improving our products.