

Thor-C

free standing luminaires



20.015.34012



GENERAL

Floor
Standing
Silver
IP20
indirect 3500 lm
direct 3100 lm
total 6600 lm
Beam Angle $\uparrow 110^\circ/90^\circ \downarrow$
UGR < 17

LED

4000K neutral white
CRI ≥ 80
L80(B10)50,000H
SDCM < 3

PHYSICAL

length 610 mm
width 300 mm
height 1950 mm
12.5 kg

ELECTRICAL

60W
110 lm/W
200~240V AC

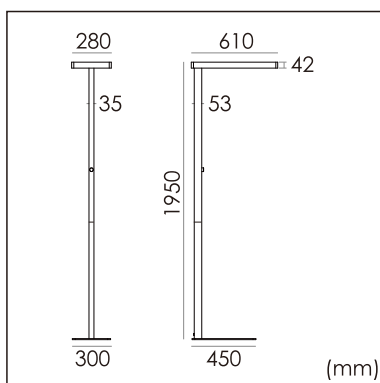

The data values for the luminous flux are initially subject to a tolerance of +/- 10%, those for the electrical connected load are initially subject to a tolerance of +/- 10%, and those for the colour temperature are initially subject to a tolerance of +/- 150 K. Product illustrations serve as examples and may differ from the original. No liability is assumed for typographical or printing errors. We reserve the right to make alterations in the interest of improving our products.