

20.014.24004



GENERAL

Floor
 Standing
 White
 IP20
 indirect 2200 lm
 direct 3300 lm
 total 5500 lm
 Beam Angle $\uparrow 160^\circ / 150^\circ \downarrow$
 UGR < 22

LED

4000K neutral white
 CRI ≥ 80
 L80(B10)50,000H
 SDCM < 3

PHYSICAL

length 645 mm
 width 310 mm
 height 1950 mm
 10 kg

ELECTRICAL

55W
 100 lm/W
 200~240V AC

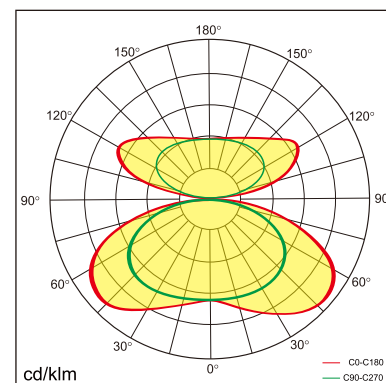
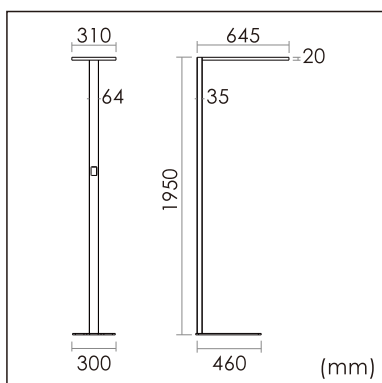

The data values for the luminous flux are initially subject to a tolerance of +/- 10%, those for the electrical connected load are initially subject to a tolerance of +/- 10%, and those for the colour temperature are initially subject to a tolerance of +/- 150 K. Product illustrations serve as examples and may differ from the original. No liability is assumed for typographical or printing errors. We reserve the right to make alterations in the interest of improving our products.