

Freyr-F

free standing luminaire



20.011.36009



GENERAL

Floor
Standing
Silver
IP20
indirect 5500 lm
direct 2500 lm
total 8000 lm
Beam Angle $\uparrow 140^\circ/50^\circ\downarrow$
UGR < 6

LED

3000~6000K Variable
CRI ≥ 80
L80(B10)50,000H
SDCM < 3

PHYSICAL

length 1056 mm
width 225 mm
height 1950 mm
11.3 kg

ELECTRICAL

80W
100 lm/W
AC200~240V

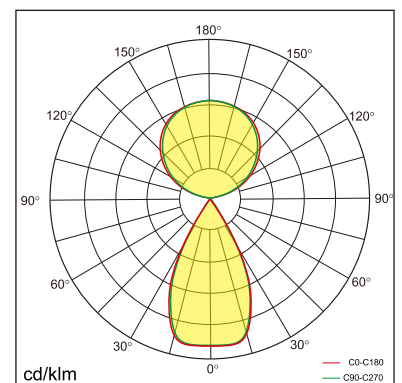
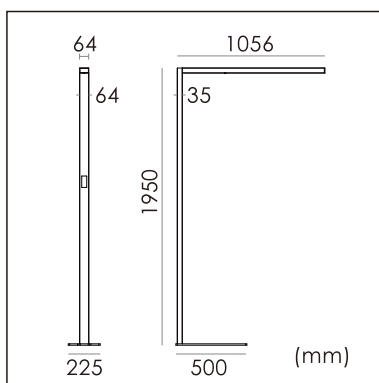

The data values for the luminous flux are initially subject to a tolerance of +/- 10%, those for the electrical connected load are initially subject to a tolerance of +/- 10%, and those for the colour temperature are initially subject to a tolerance of +/- 150 K. Product illustrations serve as examples and may differ from the original. No liability is assumed for typographical or printing errors. We reserve the right to make alterations in the interest of improving our products.