

# Ymer-F free standing luminaire



20.001.14023



## GENERAL

Floor  
Standing  
black  
IP20  
indirect 10500 lm  
direct 2800 lm  
total 13300 lm  
Beam Angle  $\uparrow 115^\circ / 75^\circ \downarrow$   
UGR < 14

## LED

4000K neutral white  
CRI  $\geq 80$   
L80(B10)50,000H  
SDCM < 3

## PHYSICAL

length 835 mm  
width 270 mm  
height 1960 mm  
15.1 kg

## ELECTRICAL

100W  
135 lm/W  
200~240V AC

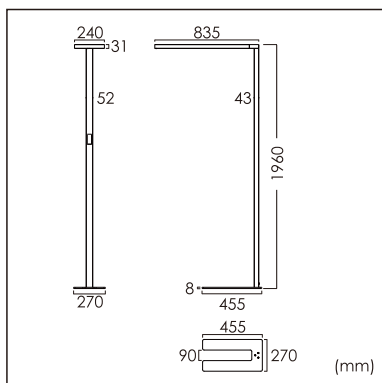

The data values for the luminous flux are initially subject to a tolerance of +/- 10%, those for the electrical connected load are initially subject to a tolerance of +/- 10%, and those for the colour temperature are initially subject to a tolerance of +/- 150 K. Product illustrations serve as examples and may differ from the original. No liability is assumed for typographical or printing errors. We reserve the right to make alterations in the interest of improving our products.