

# Ymer-F free standing luminaire



20.001.33005



## GENERAL

Floor  
Standing  
Silver  
IP20  
indirect 7280 lm  
direct 3120 lm  
total 10400 lm  
Beam Angle  $\uparrow 115^\circ / 75^\circ \downarrow$   
UGR < 14

## LED

3000K warm white  
CRI  $\geq 80$   
L80(B10)50,000H  
SDCM < 3

## PHYSICAL

length 835 mm  
width 270 mm  
height 1960 mm  
15.1 kg

## ELECTRICAL

80W  
130 lm/W  
200~240V AC

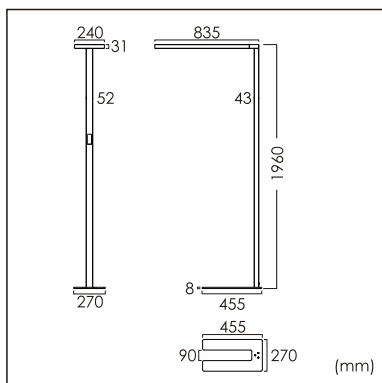

The data values for the luminous flux are initially subject to a tolerance of +/- 10%, those for the electrical connected load are initially subject to a tolerance of +/- 10%, and those for the colour temperature are initially subject to a tolerance of +/- 150 K. Product illustrations serve as examples and may differ from the original. No liability is assumed for typographical or printing errors. We reserve the right to make alterations in the interest of improving our products.