

Ymer-F free standing luminaire



20.001.23016



GENERAL

Floor
Standing
White
IP20
indirect 10500 lm
direct 2800 lm
total 13300 lm
Beam Angle $\uparrow 115^\circ / 75^\circ \downarrow$
UGR < 14

LED

3000K warm white
CRI ≥ 80
L80(B10)50,000H
SDCM < 3

PHYSICAL

length 835 mm
width 270 mm
height 1960 mm
15.1 kg

ELECTRICAL

100W
135 lm/W
200~240V AC

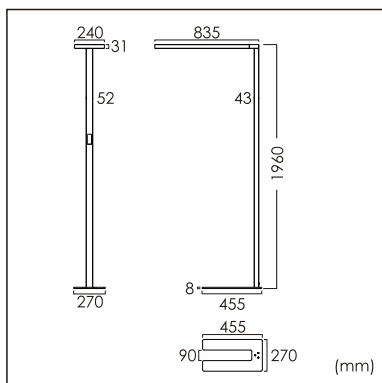

The data values for the luminous flux are initially subject to a tolerance of +/- 10%, those for the electrical connected load are initially subject to a tolerance of +/- 10%, and those for the colour temperature are initially subject to a tolerance of +/- 150 K. Product illustrations serve as examples and may differ from the original. No liability is assumed for typographical or printing errors. We reserve the right to make alterations in the interest of improving our products.