

22.002.34018



GENERAL

Ceiling
Suspended
Silver
IP20
indirect 2700 lm
direct 3650 lm
total 6350 lm
Beam Angle $\uparrow 115^\circ/80^\circ\downarrow$
UGR<19

LED

4000K neutral white
CRI ≥ 80
L80(B10)50,000H
SDCM <3

PHYSICAL

length 1200 mm
width 240 mm
height 32.8 mm
4.85 kg

ELECTRICAL

50W
125 lm/W
DALI Dimming
AC200~240V

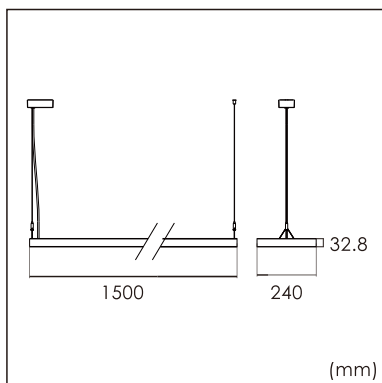

The data values for the luminous flux are initially subject to a tolerance of +/- 10%, those for the electrical connected load are initially subject to a tolerance of +/- 10%, and those for the colour temperature are initially subject to a tolerance of +/- 150 K. Product illustrations serve as examples and may differ from the original. No liability is assumed for typographical or printing errors. We reserve the right to make alterations in the interest of improving our products.