

22.004.33011

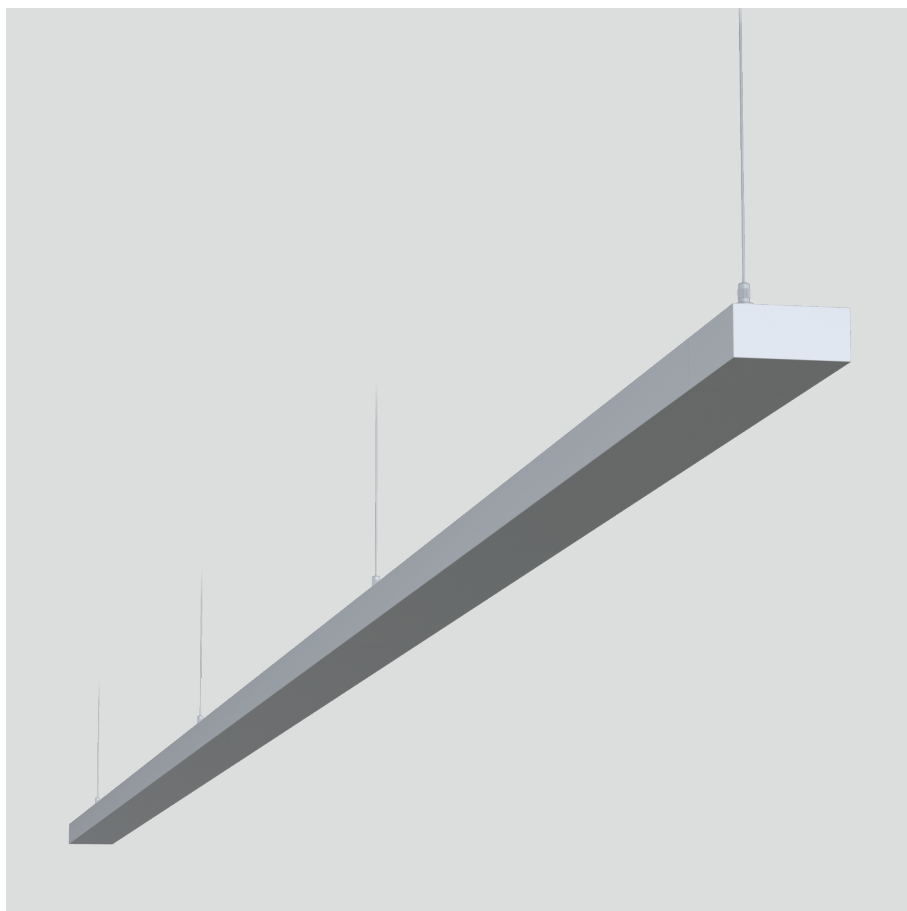

GENERAL

Ceiling
Suspended
Silver
IP20
indirect 1000 lm
total 1000 lm
Beam Angle \uparrow 160°
UGR<6

LED

3000K warm white
CRI \geq 80
L80(B10)50,000H
SDCM <3

PHYSICAL

length 1216 mm
width 55 mm
height 28 mm
2.2 kg

ELECTRICAL

10W
100 lm/W
No Dimming
AC200~240V

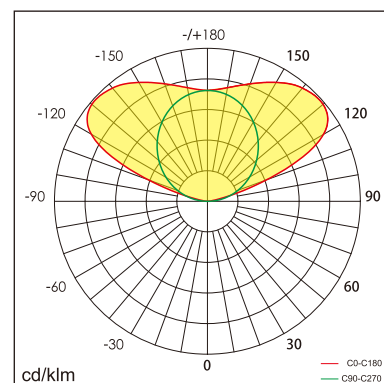
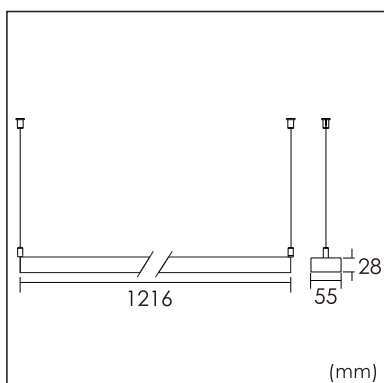

The data values for the luminous flux are initially subject to a tolerance of +/- 10%, those for the electrical connected load are initially subject to a tolerance of +/- 10%, and those for the colour temperature are initially subject to a tolerance of +/- 150 K. Product illustrations serve as examples and may differ from the original. No liability is assumed for typographical or printing errors. We reserve the right to make alterations in the interest of improving our products.