

Freyr-P2

pendant luminaires



22.011.14008



GENERAL

Ceiling
Suspended
black
IP20
indirect 2950 lm
direct 2550 lm
total 5500 lm
Beam Angle $\uparrow 115^\circ / 50^\circ \downarrow$
UGR < 6

LED

4000K neutral white
CRI ≥ 80
L80(B10)50,000H
SDCM < 3

PHYSICAL

length 1175 mm
width 38 mm
height 66 mm
2.75 kg

ELECTRICAL

50W
110 lm/W
1-10V Dimming
AC200~240V

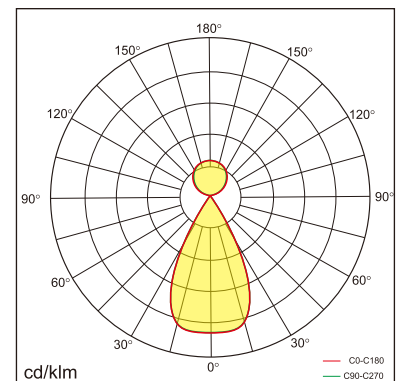
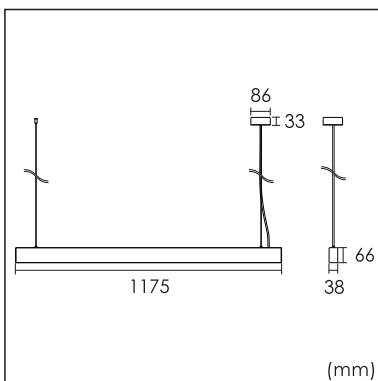

The data values for the luminous flux are initially subject to a tolerance of +/- 10%, those for the electrical connected load are initially subject to a tolerance of +/- 10%, and those for the colour temperature are initially subject to a tolerance of +/- 150 K. Product illustrations serve as examples and may differ from the original. No liability is assumed for typographical or printing errors. We reserve the right to make alterations in the interest of improving our products.