

Freyr-P2 pendant luminaires



22.011.34036



GENERAL

Ceiling
Suspended
Silver
IP20
indirect 3550 lm
direct 3050 lm
total 6600 lm
Beam Angle $\uparrow 115^\circ / 50^\circ \downarrow$
UGR < 6

LED

4000K neutral white
CRI ≥ 80
L80(B10)50,000H
SDCM < 3

PHYSICAL

length 1493 mm
width 38 mm
height 66 mm
4.2 kg

ELECTRICAL

60W
110 lm/W
DALI Dimming
AC200~240V

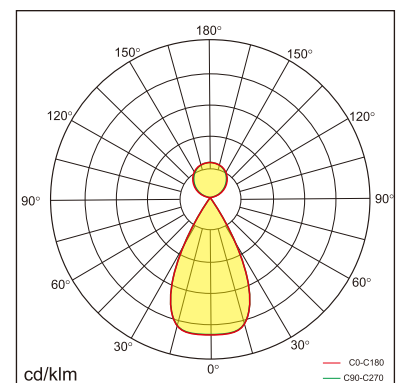
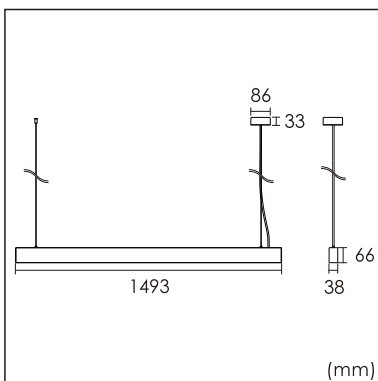

The data values for the luminous flux are initially subject to a tolerance of +/- 10%, those for the electrical connected load are initially subject to a tolerance of +/- 10%, and those for the colour temperature are initially subject to a tolerance of +/- 150 K. Product illustrations serve as examples and may differ from the original. No liability is assumed for typographical or printing errors. We reserve the right to make alterations in the interest of improving our products.