

# Freyr-P1

pendant luminaires



22.010.24016



## GENERAL

Ceiling  
Suspended  
White  
IP20  
indirect 3400 lm  
direct 3300 lm  
total 6700 lm  
Beam Angle  $\uparrow 115^\circ / 50^\circ \downarrow$   
UGR < 6

## LED

4000K neutral white  
CRI  $\geq 80$   
L80(B10)50,000H  
SDCM < 3

## PHYSICAL

length 1190 mm  
width 160 mm  
height 30 mm  
4.1 kg

## ELECTRICAL

60W  
110 lm/W  
DALI Dimming  
AC200~240V

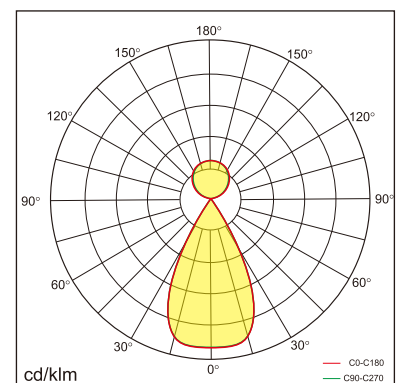
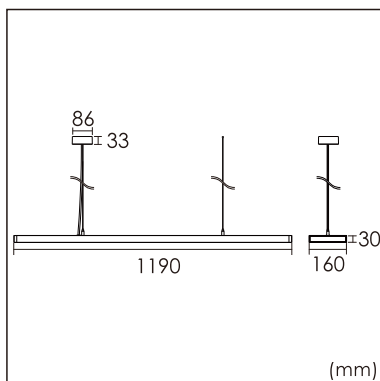

The data values for the luminous flux are initially subject to a tolerance of +/- 10%, those for the electrical connected load are initially subject to a tolerance of +/- 10%, and those for the colour temperature are initially subject to a tolerance of +/- 150 K. Product illustrations serve as examples and may differ from the original. No liability is assumed for typographical or printing errors. We reserve the right to make alterations in the interest of improving our products.