

22.008.24064

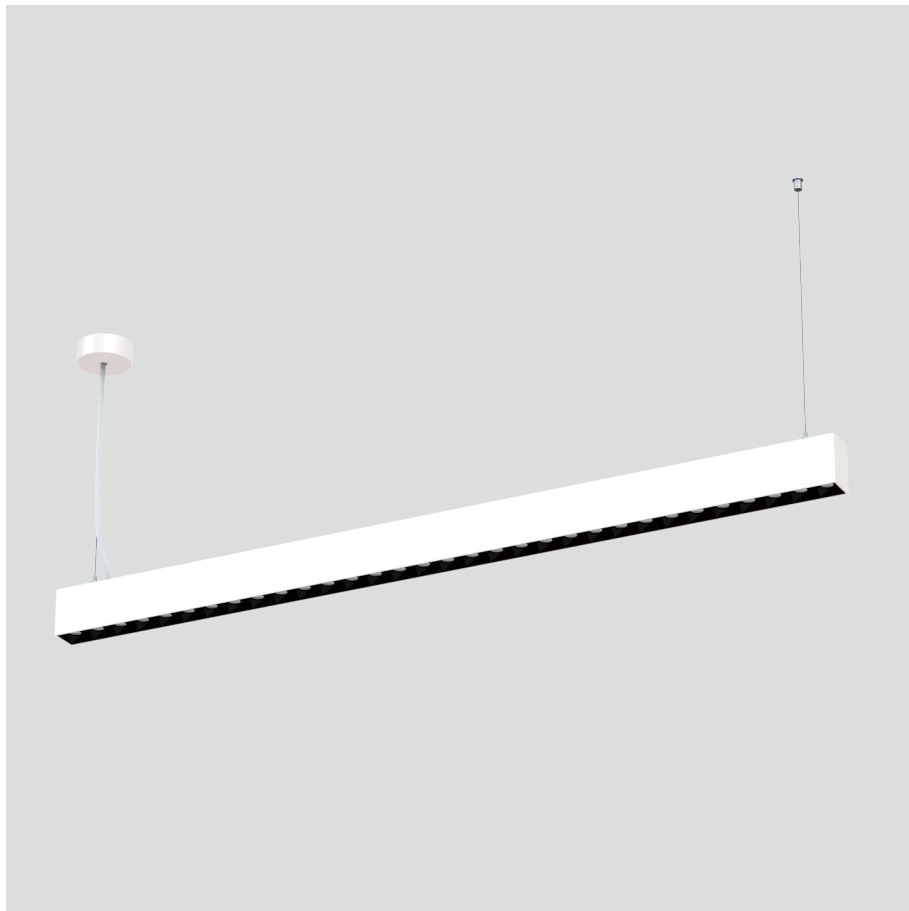

### GENERAL

Ceiling  
Suspended  
White  
IP20  
indirect 5050 lm  
direct 4050 lm  
total 9100 lm (SMD5050)  
indirect 4100 lm  
direct 3300 lm  
total 7400 lm (SMD2835)  
Beam Angle  $\uparrow 140^\circ/80^\circ \downarrow$   
UGR<15

### LED

4000K neutral white  
CRI  $\geq 80$   
L80(B10)50,000H  
SDCM <3

### PHYSICAL

length 1488 mm  
width 48 mm  
height 76 mm  
3.7 kg

### ELECTRICAL

70W  
130 lm/W  
1-10V Dimming  
AC200~240V

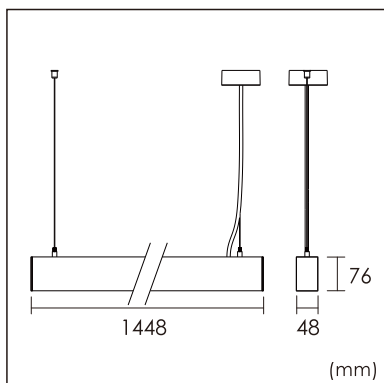

The data values for the luminous flux are initially subject to a tolerance of +/- 10%, those for the electrical connected load are initially subject to a tolerance of +/- 10%, and those for the colour temperature are initially subject to a tolerance of +/- 150 K. Product illustrations serve as examples and may differ from the original. No liability is assumed for typographical or printing errors. We reserve the right to make alterations in the interest of improving our products.