

22.008.34042

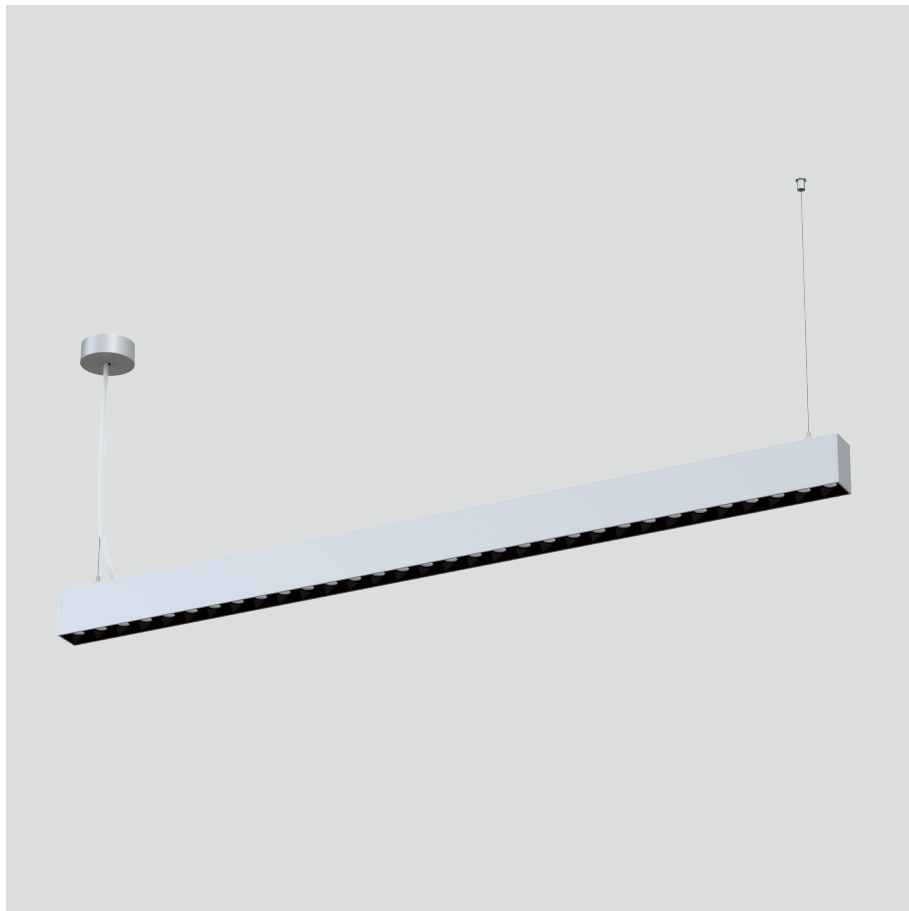

GENERAL

Ceiling
Suspended
Silver
IP20
indirect 5050 lm
direct 4050 lm
total 9100 lm (SMD5050)
indirect 4100 lm
direct 3300 lm
total 7400 lm (SMD2835)
Beam Angle $\uparrow 140^\circ / 50^\circ \downarrow$
UGR < 15

LED

4000K neutral white
CRI ≥ 80
L80(B10)50,000H
SDCM < 3

PHYSICAL

length 1488 mm
width 48 mm
height 76 mm
3.7 kg

ELECTRICAL

70W
130 lm/W
No Dimming
AC200~240V

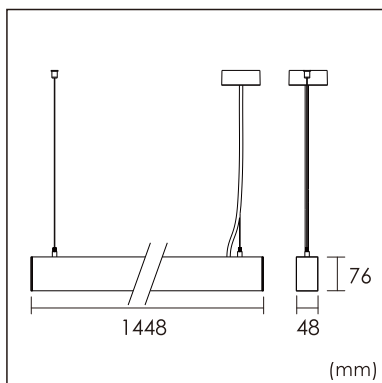

The data values for the luminous flux are initially subject to a tolerance of +/- 10%, those for the electrical connected load are initially subject to a tolerance of +/- 10%, and those for the colour temperature are initially subject to a tolerance of +/- 150 K. Product illustrations serve as examples and may differ from the original. No liability is assumed for typographical or printing errors. We reserve the right to make alterations in the interest of improving our products.