

22.008.34036

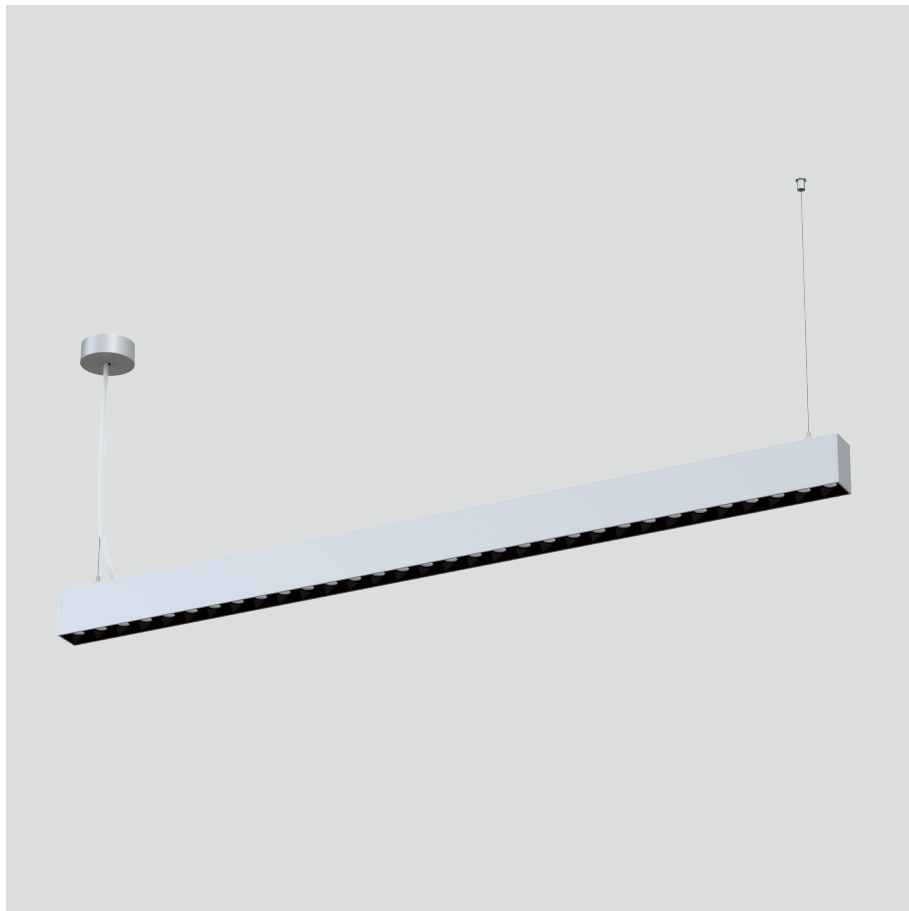

### GENERAL

Ceiling  
Suspended  
Silver  
IP20  
indirect 4200 lm  
direct 3250 lm  
total 7450 lm (SMD5050)  
indirect 3500 lm  
direct 2800 lm  
total 6300 lm (SMD2835)  
Beam Angle  $\uparrow 140^\circ/80^\circ \downarrow$   
UGR<15

### LED

4000K neutral white  
CRI  $\geq 80$   
L80(B10)50,000H  
SDCM <3

### PHYSICAL

length 1288 mm  
width 48 mm  
height 76 mm  
3.2 kg

### ELECTRICAL

60W  
125 lm/W  
DALI Dimming  
AC200~240V

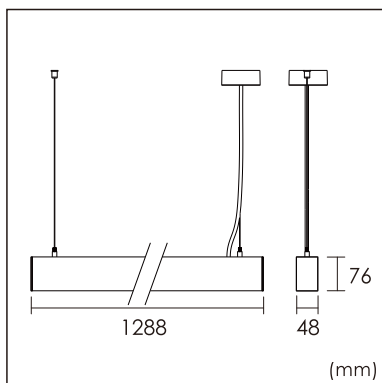

The data values for the luminous flux are initially subject to a tolerance of +/- 10%, those for the electrical connected load are initially subject to a tolerance of +/- 10%, and those for the colour temperature are initially subject to a tolerance of +/- 150 K. Product illustrations serve as examples and may differ from the original. No liability is assumed for typographical or printing errors. We reserve the right to make alterations in the interest of improving our products.