

# Baldur-P

pendant luminaires



22.006.33065



## GENERAL

Ceiling  
Suspended  
Silver  
IP20  
indirect 3400 lm  
direct 6200 lm  
total 9600 lm  
Beam Angle  $\uparrow 100^\circ / 95^\circ \downarrow$   
UGR < 15

## LED

3000K warm white  
CRI  $\geq 80$   
L80(B10)50,000H  
SDCM < 3

## PHYSICAL

diameter 900 mm  
height 82 mm  
11.9 kg

## ELECTRICAL

80W  
120 lm/W  
1-10V Dimming  
AC200~240V

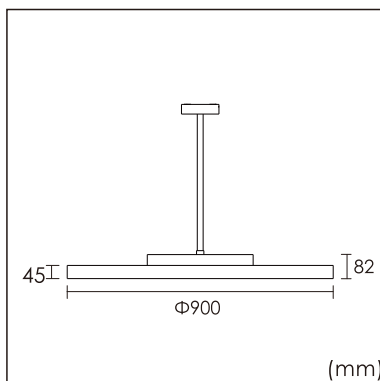

The data values for the luminous flux are initially subject to a tolerance of +/- 10%, those for the electrical connected load are initially subject to a tolerance of +/- 10%, and those for the colour temperature are initially subject to a tolerance of +/- 150 K. Product illustrations serve as examples and may differ from the original. No liability is assumed for typographical or printing errors. We reserve the right to make alterations in the interest of improving our products.