

Baldur-P

pendant luminaires



22.006.14068



GENERAL

Ceiling
Suspended
black
IP20
indirect 3400 lm
direct 6200 lm
total 9600 lm
Beam Angle $\uparrow 100^\circ / 95^\circ \downarrow$
UGR < 15

LED

4000K neutral white
CRI ≥ 80
L80(B10)50,000H
SDCM < 3

PHYSICAL

diameter 900 mm
height 82 mm
11.9 kg

ELECTRICAL

80W
120 lm/W
DALI Dimming
AC200~240V

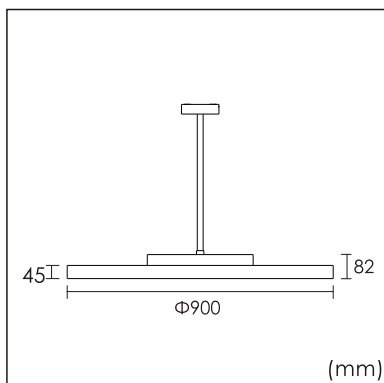

The data values for the luminous flux are initially subject to a tolerance of +/- 10%, those for the electrical connected load are initially subject to a tolerance of +/- 10%, and those for the colour temperature are initially subject to a tolerance of +/- 150 K. Product illustrations serve as examples and may differ from the original. No liability is assumed for typographical or printing errors. We reserve the right to make alterations in the interest of improving our products.