

22.008.24028

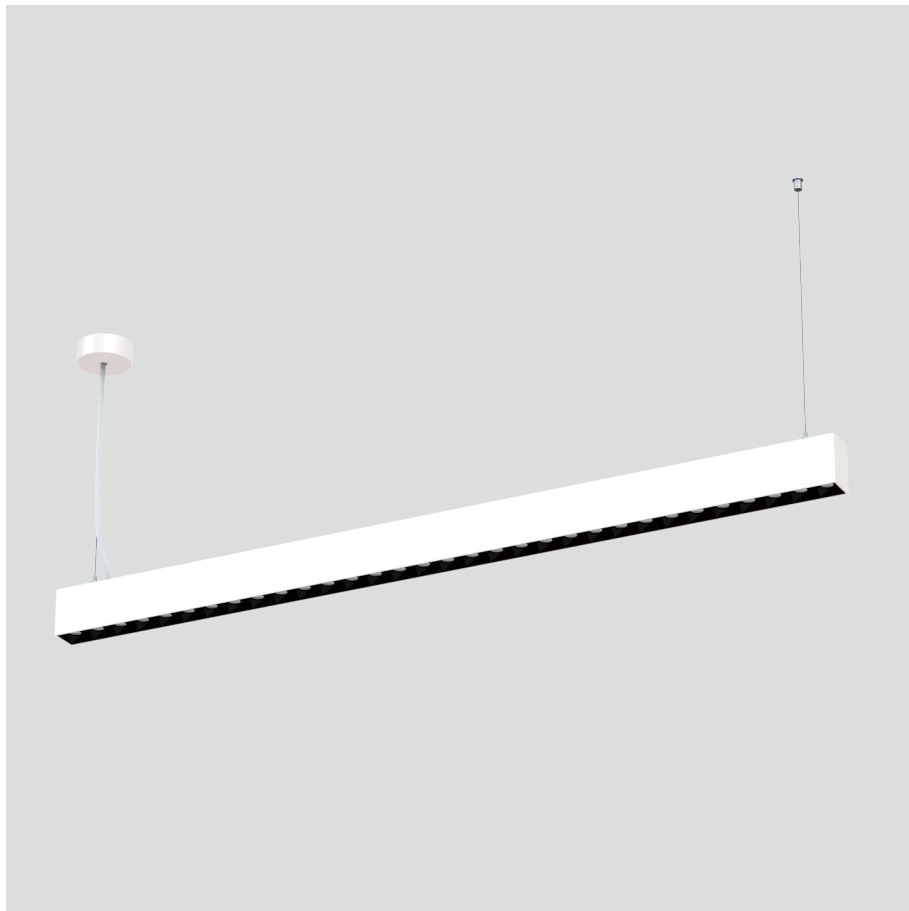

GENERAL

Ceiling
Suspended
White
IP20
indirect 4200 lm
direct 3250 lm
total 7450 lm (SMD5050)
indirect 3500 lm
direct 2800 lm
total 6300 lm (SMD2835)
Beam Angle $\uparrow 140^\circ/80^\circ \downarrow$
UGR<15

LED

4000K neutral white
CRI ≥ 80
L80(B10)50,000H
SDCM <3

PHYSICAL

length 1288 mm
width 48 mm
height 76 mm
3.2 kg

ELECTRICAL

60W
125 lm/W
1-10V Dimming
AC200~240V

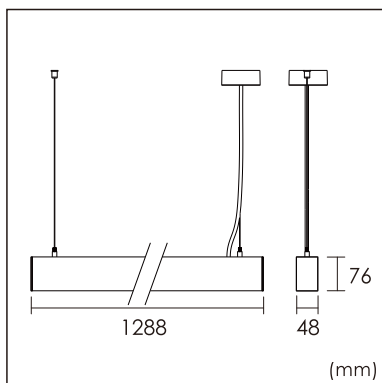

The data values for the luminous flux are initially subject to a tolerance of +/- 10%, those for the electrical connected load are initially subject to a tolerance of +/- 10%, and those for the colour temperature are initially subject to a tolerance of +/- 150 K. Product illustrations serve as examples and may differ from the original. No liability is assumed for typographical or printing errors. We reserve the right to make alterations in the interest of improving our products.