

Baldur-P

pendant luminaires



22.006.34042



GENERAL

Ceiling
Suspended
Silver
IP20
indirect 1960 lm
direct 3800 lm
total 5760 lm
Beam Angle $\uparrow 100^\circ / 95^\circ \downarrow$
UGR < 17

LED

4000K neutral white
CRI ≥ 80
L80(B10)50,000H
SDCM < 3

PHYSICAL

diameter 600 mm
height 82 mm
6.65 kg

ELECTRICAL

48W
120 lm/W
No Dimming
AC200~240V

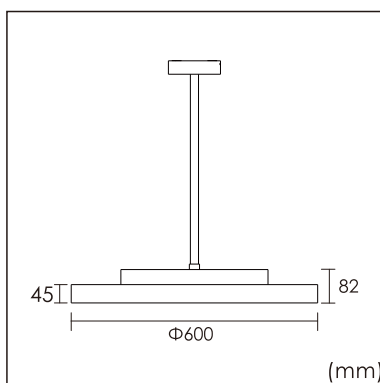

The data values for the luminous flux are initially subject to a tolerance of +/- 10%, those for the electrical connected load are initially subject to a tolerance of +/- 10%, and those for the colour temperature are initially subject to a tolerance of +/- 150 K. Product illustrations serve as examples and may differ from the original. No liability is assumed for typographical or printing errors. We reserve the right to make alterations in the interest of improving our products.