

# Baldur-P

pendant luminaires



22.006.14026



## GENERAL

Ceiling  
Suspended  
black  
IP20  
indirect 1000 lm  
direct 2100 lm  
total 3100 lm  
Beam Angle  $\uparrow 100^\circ / 95^\circ \downarrow$   
UGR < 18

## LED

4000K neutral white  
CRI  $\geq 80$   
L80(B10)50,000H  
SDCM < 3

## PHYSICAL

diameter 450 mm  
height 82 mm  
4.35 kg

## ELECTRICAL

30W  
100 lm/W  
1-10V Dimming  
AC200~240V

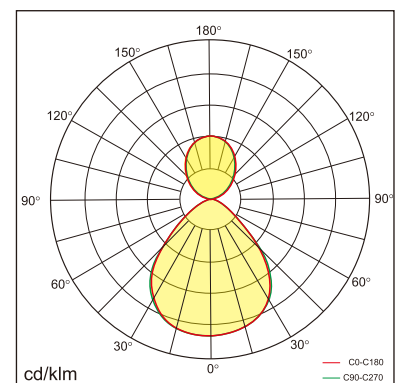
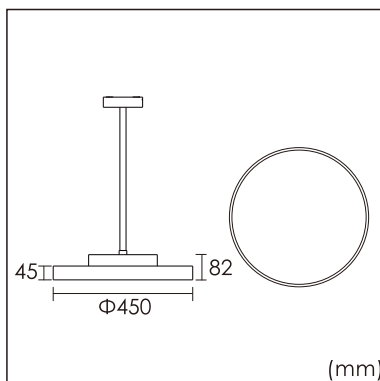

The data values for the luminous flux are initially subject to a tolerance of +/- 10%, those for the electrical connected load are initially subject to a tolerance of +/- 10%, and those for the colour temperature are initially subject to a tolerance of +/- 150 K. Product illustrations serve as examples and may differ from the original. No liability is assumed for typographical or printing errors. We reserve the right to make alterations in the interest of improving our products.