

Siv-C3

Surface mounted luminaires



23.007.14020



GENERAL

Ceiling
Surface
black
IP20
1900 lm
Beam Angle 35°
UGR<17

LED

4000K neutral white
CRI ≥ 80
L80(B10)50,000H
SDCM <3

PHYSICAL

length 128 mm
width 128 mm
height 88 mm
0.8 kg

ELECTRICAL

18W
110 lm/W
No Dimming
AC200~240V

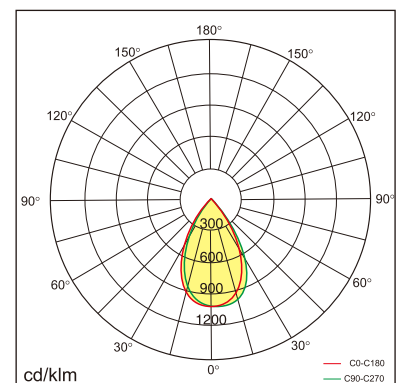
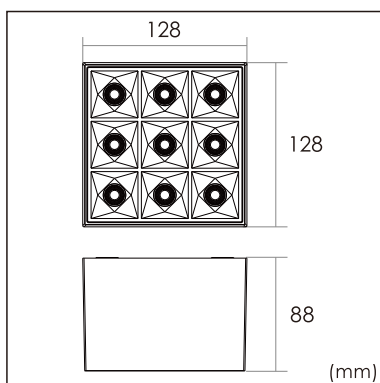

The data values for the luminous flux are initially subject to a tolerance of +/- 10%, those for the electrical connected load are initially subject to a tolerance of +/- 10%, and those for the colour temperature are initially subject to a tolerance of +/- 150 K. Product illustrations serve as examples and may differ from the original. No liability is assumed for typographical or printing errors. We reserve the right to make alterations in the interest of improving our products.