

Freyr-C2

Surface mounted luminaires



23.010.14008



GENERAL

Ceiling
Surface
black
IP20
3000 lm
Beam Angle 50°
UGR<10

LED

4000K neutral white
CRI ≥ 80
L80(B10)50,000H
SDCM <3

PHYSICAL

length 960 mm
width 40 mm
height 80 mm
2.6 kg

ELECTRICAL

30W
100 lm/W
1-10V Dimming
AC200~240V

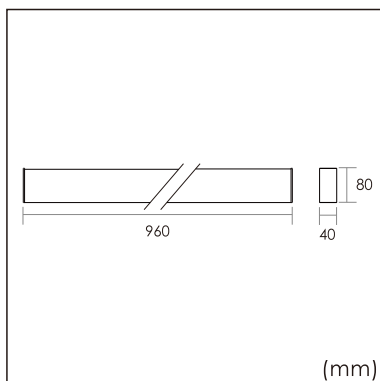

The data values for the luminous flux are initially subject to a tolerance of +/- 10%, those for the electrical connected load are initially subject to a tolerance of +/- 10%, and those for the colour temperature are initially subject to a tolerance of +/- 150 K. Product illustrations serve as examples and may differ from the original. No liability is assumed for typographical or printing errors. We reserve the right to make alterations in the interest of improving our products.