

# Baldur-C

Surface mounted luminaires



23.004.14086



## GENERAL

Ceiling  
Surface  
black  
IP20  
indirect 3400 lm  
direct 6200 lm  
total 9600 lm  
Beam Angle  $\uparrow$ 110°/95° $\downarrow$   
UGR<15

## LED

4000K neutral white  
CRI  $\geq$  80  
L80(B10)50,000H  
SDCM <3

## PHYSICAL

diameter 900 mm  
height 82 mm  
11.3 kg

## ELECTRICAL

80W  
120 lm/W  
DALI Dimming  
AC200~240V

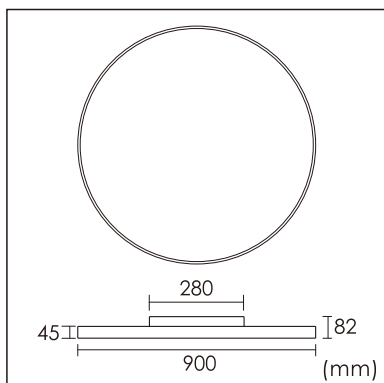

The data values for the luminous flux are initially subject to a tolerance of +/- 10%, those for the electrical connected load are initially subject to a tolerance of +/- 10%, and those for the colour temperature are initially subject to a tolerance of +/- 150 K. Product illustrations serve as examples and may differ from the original. No liability is assumed for typographical or printing errors. We reserve the right to make alterations in the interest of improving our products.