

Baldur-C

Surface mounted luminaires



23.004.13025



GENERAL

Ceiling
Surface
black
IP20
indirect 1100 lm
direct 2200 lm
total 3100 lm
Beam Angle $\uparrow 110^\circ/95^\circ\downarrow$
UGR<18

LED

3000K warm white
CRI ≥ 80
L80(B10)50,000H
SDCM <3

PHYSICAL

diameter 450 mm
height 82 mm
3.7 kg

ELECTRICAL

30W
110 lm/W
No Dimming
AC200~240V

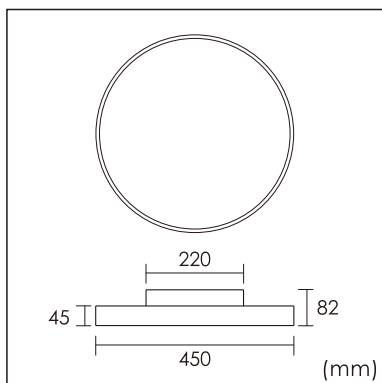

The data values for the luminous flux are initially subject to a tolerance of +/- 10%, those for the electrical connected load are initially subject to a tolerance of +/- 10%, and those for the colour temperature are initially subject to a tolerance of +/- 150 K. Product illustrations serve as examples and may differ from the original. No liability is assumed for typographical or printing errors. We reserve the right to make alterations in the interest of improving our products.