

23.006.34024

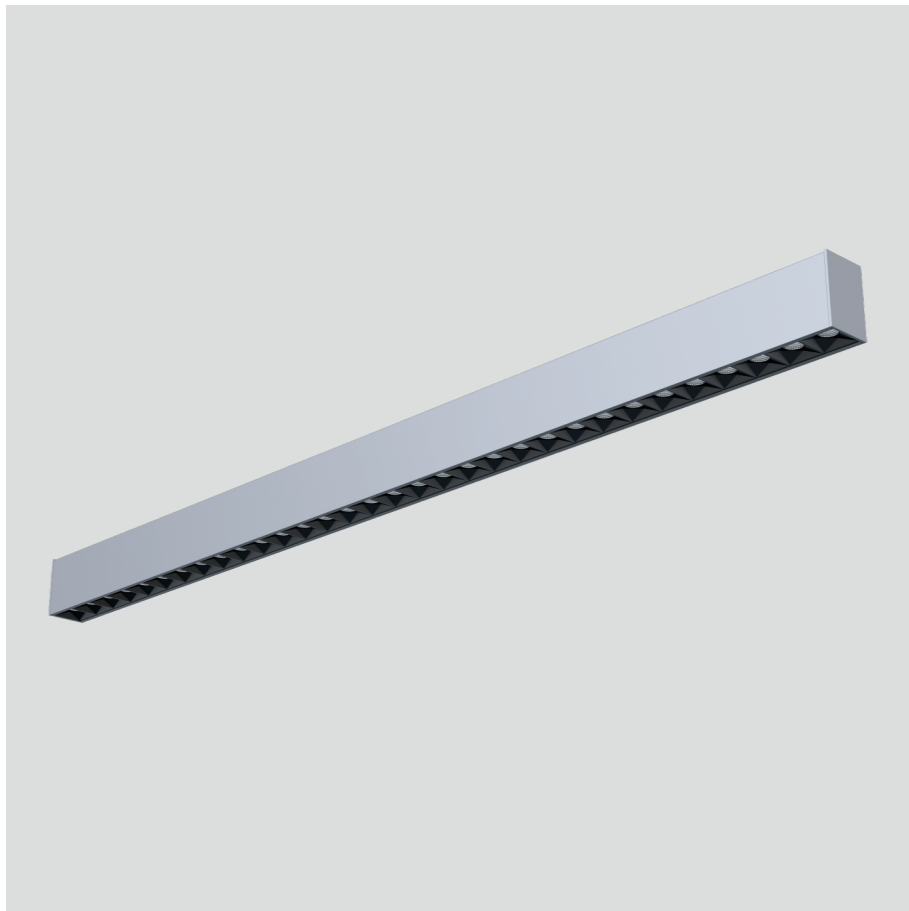

### GENERAL

Ceiling  
Surface  
Silver  
IP20  
3600 lm  
Beam Angle 80°  
UGR<18

### LED

4000K neutral white  
CRI ≥ 80  
L80(B10)50,000H  
SDCM <3

### PHYSICAL

length 1450 mm  
width 53 mm  
height 78 mm  
4.1 kg

### ELECTRICAL

35W  
110 lm/W  
No Dimming  
AC200~240V

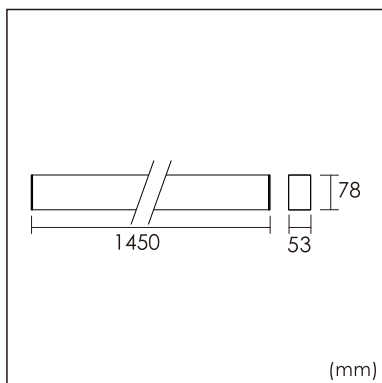

The data values for the luminous flux are initially subject to a tolerance of +/- 10%, those for the electrical connected load are initially subject to a tolerance of +/- 10%, and those for the colour temperature are initially subject to a tolerance of +/- 150 K. Product illustrations serve as examples and may differ from the original. No liability is assumed for typographical or printing errors. We reserve the right to make alterations in the interest of improving our products.