

# Baldur-C

Surface mounted luminaires



23.004.24004



## GENERAL

Ceiling  
Surface  
White  
IP20  
indirect 500 lm  
direct 1200 lm  
total 1700 lm  
Beam Angle  $\uparrow$ 110°/95° $\downarrow$   
UGR<18

## LED

4000K neutral white  
CRI  $\geq$  80  
L80(B10)50,000H  
SDCM <3

## PHYSICAL

diameter 350 mm  
height 82 mm  
2.8 kg

## ELECTRICAL

18W  
100 lm/W  
No Dimming  
AC200~240V

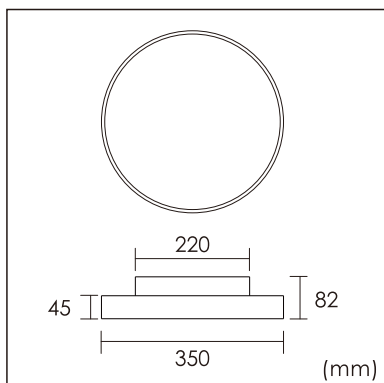

The data values for the luminous flux are initially subject to a tolerance of +/- 10%, those for the electrical connected load are initially subject to a tolerance of +/- 10%, and those for the colour temperature are initially subject to a tolerance of +/- 150 K. Product illustrations serve as examples and may differ from the original. No liability is assumed for typographical or printing errors. We reserve the right to make alterations in the interest of improving our products.