

Baldur-C

Surface mounted luminaires



23.004.13007



GENERAL

Ceiling
Surface
black
IP20
indirect 500 lm
direct 1200 lm
total 1700 lm
Beam Angle $\uparrow 110^\circ/95^\circ\downarrow$
UGR<18

LED

3000K warm white
CRI ≥ 80
L80(B10)50,000H
SDCM <3

PHYSICAL

diameter 350 mm
height 82 mm
2.8 kg

ELECTRICAL

18W
100 lm/W
1-10V Dimming
AC200~240V

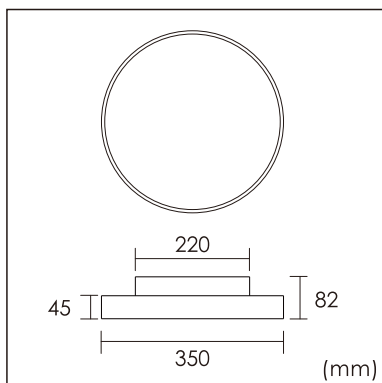

The data values for the luminous flux are initially subject to a tolerance of +/- 10%, those for the electrical connected load are initially subject to a tolerance of +/- 10%, and those for the colour temperature are initially subject to a tolerance of +/- 150 K. Product illustrations serve as examples and may differ from the original. No liability is assumed for typographical or printing errors. We reserve the right to make alterations in the interest of improving our products.