

23.006.33005

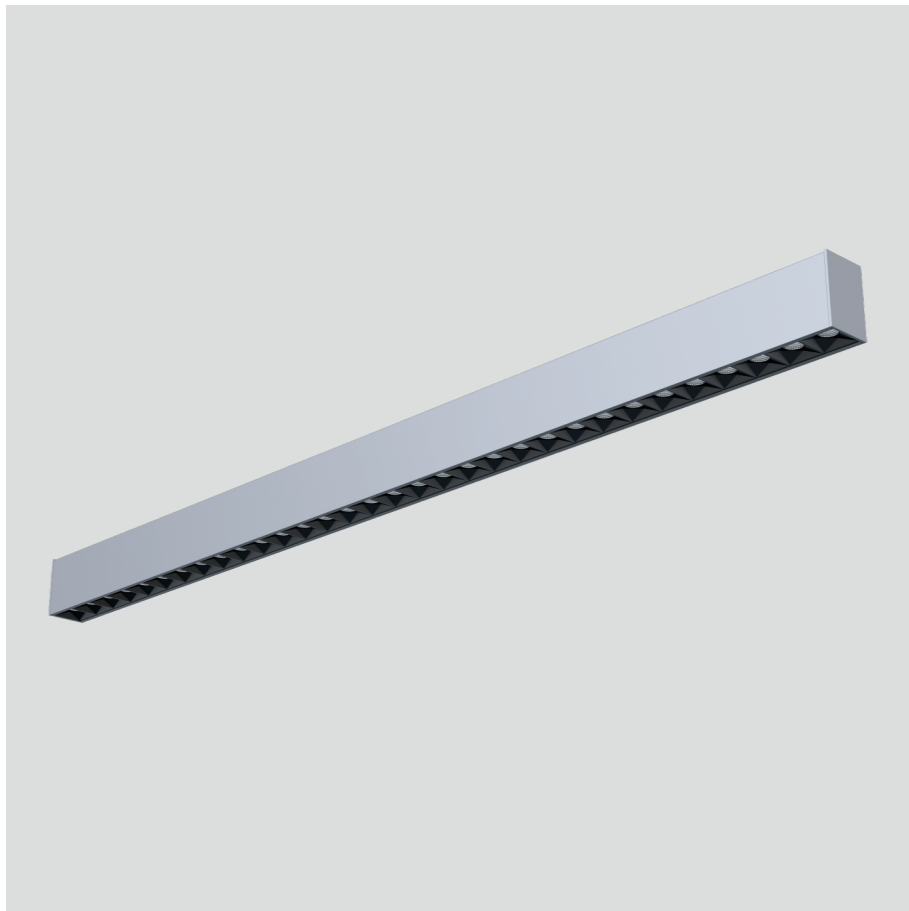

GENERAL

Ceiling
Surface
Silver
IP20
3200 lm
Beam Angle 80°
UGR<18

LED

3000K warm white
CRI ≥ 80
L80(B10)50,000H
SDCM <3

PHYSICAL

length 1290 mm
width 53 mm
height 78 mm
3.8 kg

ELECTRICAL

30W
110 lm/W
No Dimming
AC200~240V

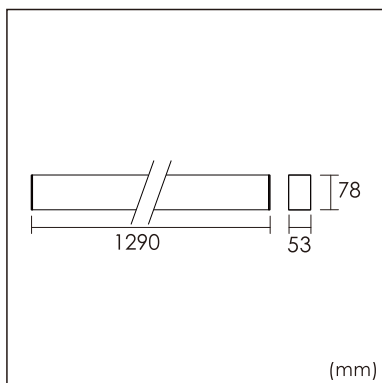

The data values for the luminous flux are initially subject to a tolerance of +/- 10%, those for the electrical connected load are initially subject to a tolerance of +/- 10%, and those for the colour temperature are initially subject to a tolerance of +/- 150 K. Product illustrations serve as examples and may differ from the original. No liability is assumed for typographical or printing errors. We reserve the right to make alterations in the interest of improving our products.