

24.001.24064



### GENERAL

Ceiling  
Recessed  
White  
IP20  
1900 lm  
Beam Angle 35°  
UGR<17

### LED

4000K neutral white  
CRI ≥ 80  
L80(B10)50,000H  
SDCM <3

### PHYSICAL

length 125 mm  
width 125 mm  
height 35 mm  
0.6 kg

### ELECTRICAL

18W  
110 lm/W  
1-10V Dimming  
AC200~240V

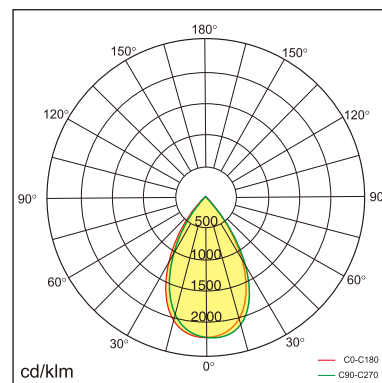
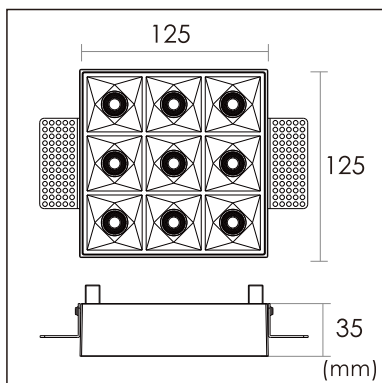

The data values for the luminous flux are initially subject to a tolerance of +/- 10%, those for the electrical connected load are initially subject to a tolerance of +/- 10%, and those for the colour temperature are initially subject to a tolerance of +/- 150 K. Product illustrations serve as examples and may differ from the original. No liability is assumed for typographical or printing errors. We reserve the right to make alterations in the interest of improving our products.