



GENERAL

Ceiling
 Recessed
 White
 IP20
 850 lm
 Beam Angle 35°
 UGR<14

LED

3000K warm white
 CRI ≥ 80
 L80(B10)50,000H
 SDCM <3

PHYSICAL

length 125 mm
 width 125 mm
 height 35 mm
 0.6 kg

ELECTRICAL

8W
 110 lm/W
 No Dimming
 AC200~240V

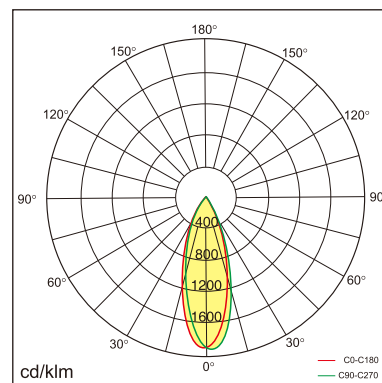
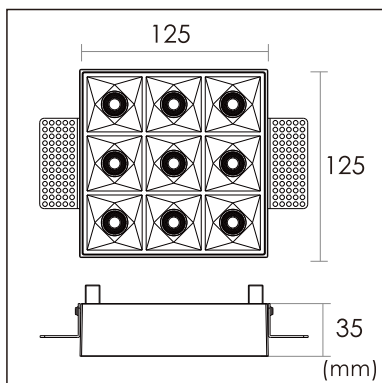

The data values for the luminous flux are initially subject to a tolerance of +/- 10%, those for the electrical connected load are initially subject to a tolerance of +/- 10%, and those for the colour temperature are initially subject to a tolerance of +/- 150 K. Product illustrations serve as examples and may differ from the original. No liability is assumed for typographical or printing errors. We reserve the right to make alterations in the interest of improving our products.