

# Siv-D3

Recessed luminaires



24.002.13007

## GENERAL

Ceiling  
Recessed  
black  
IP20  
850 lm  
Beam Angle 35°  
UGR<14

## LED

3000K warm white  
CRI ≥ 80  
L80(B10)50,000H  
SDCM <3

## PHYSICAL

length 141 mm  
width 141 mm  
height 48 mm  
0.6 kg

## ELECTRICAL

1~10V Dimming  
8W  
110 lm/W  
AC200~240V

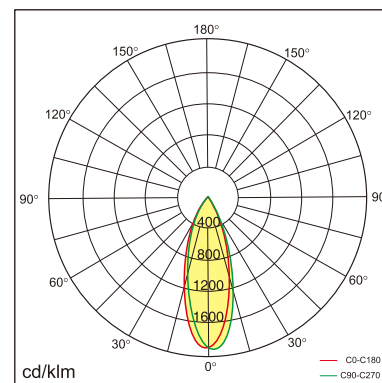
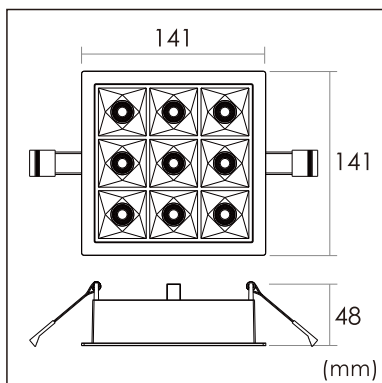

The data values for the luminous flux are initially subject to a tolerance of +/- 10%, those for the electrical connected load are initially subject to a tolerance of +/- 10%, and those for the colour temperature are initially subject to a tolerance of +/- 150 K. Product illustrations serve as examples and may differ from the original. No liability is assumed for typographical or printing errors. We reserve the right to make alterations in the interest of improving our products.