

Siv-D3

Recessed luminaires



24.002.24016

GENERAL

Ceiling
Recessed
White
IP20
850 lm
Beam Angle 35°
UGR<14

LED

4000K neutral white
CRI ≥ 80
L80(B10)50,000H
SDCM <3

PHYSICAL

length 141 mm
width 141 mm
height 48 mm
0.6 kg

ELECTRICAL

DALI Dimming
8W
110 lm/W
AC200~240V

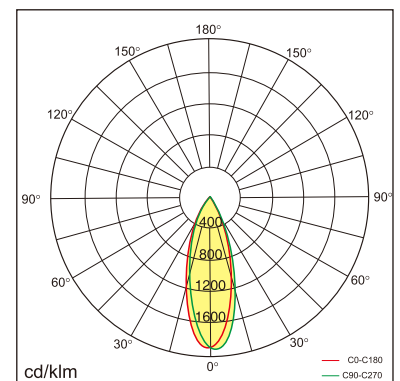
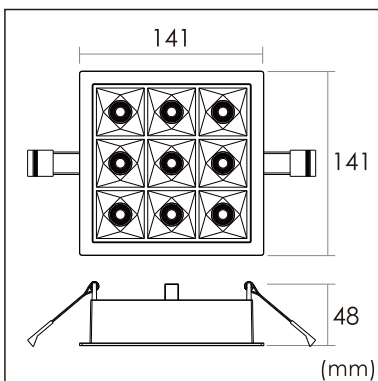

The data values for the luminous flux are initially subject to a tolerance of +/- 10%, those for the electrical connected load are initially subject to a tolerance of +/- 10%, and those for the colour temperature are initially subject to a tolerance of +/- 150 K. Product illustrations serve as examples and may differ from the original. No liability is assumed for typographical or printing errors. We reserve the right to make alterations in the interest of improving our products.