

# Freyr-R0

Recessed luminaires

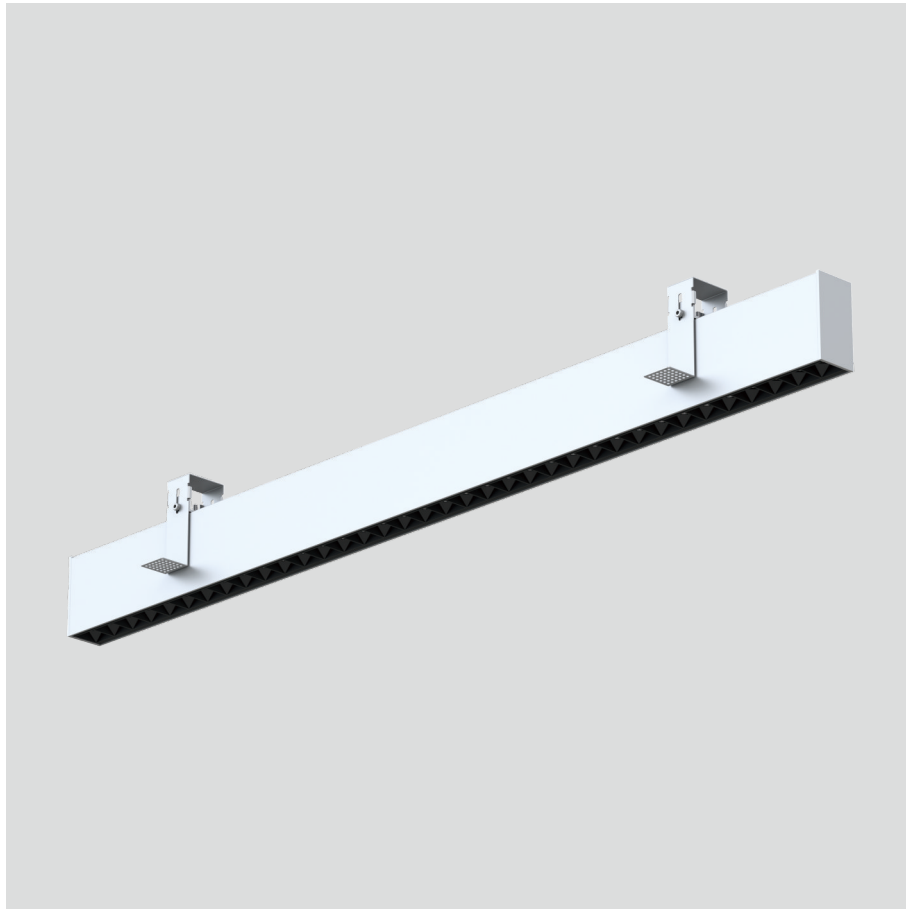

23.006.34012



## GENERAL

Ceiling  
Recessed  
Silver  
IP20  
3000 lm  
Beam Angle 50°  
UGR<10

## LED

4000K neutral white  
CRI ≥ 80  
L80(B10)50,000H  
SDCM <3

## PHYSICAL

length 960 mm  
width 40 mm  
height 80 mm  
2.8 kg

## ELECTRICAL

1~10V Dimming  
30W  
100 lm/W  
AC200~240V

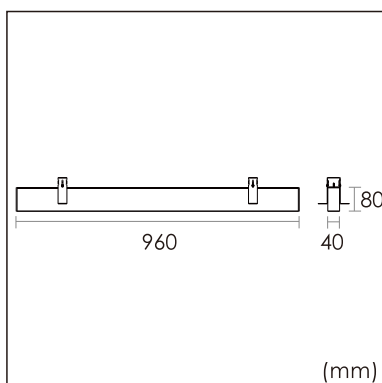

The data values for the luminous flux are initially subject to a tolerance of +/- 10%, those for the electrical connected load are initially subject to a tolerance of +/- 10%, and those for the colour temperature are initially subject to a tolerance of +/- 150 K. Product illustrations serve as examples and may differ from the original. No liability is assumed for typographical or printing errors. We reserve the right to make alterations in the interest of improving our products.